

Channel Letters

Light Box / Logo Box

LAYERED EXAMPLE

A Logo box is an optional channel letter sign element - it is basically a contoured channel letter. Logo boxes add to a sign's attention-generating capacity. And can be manufactured in a variety of sizes.

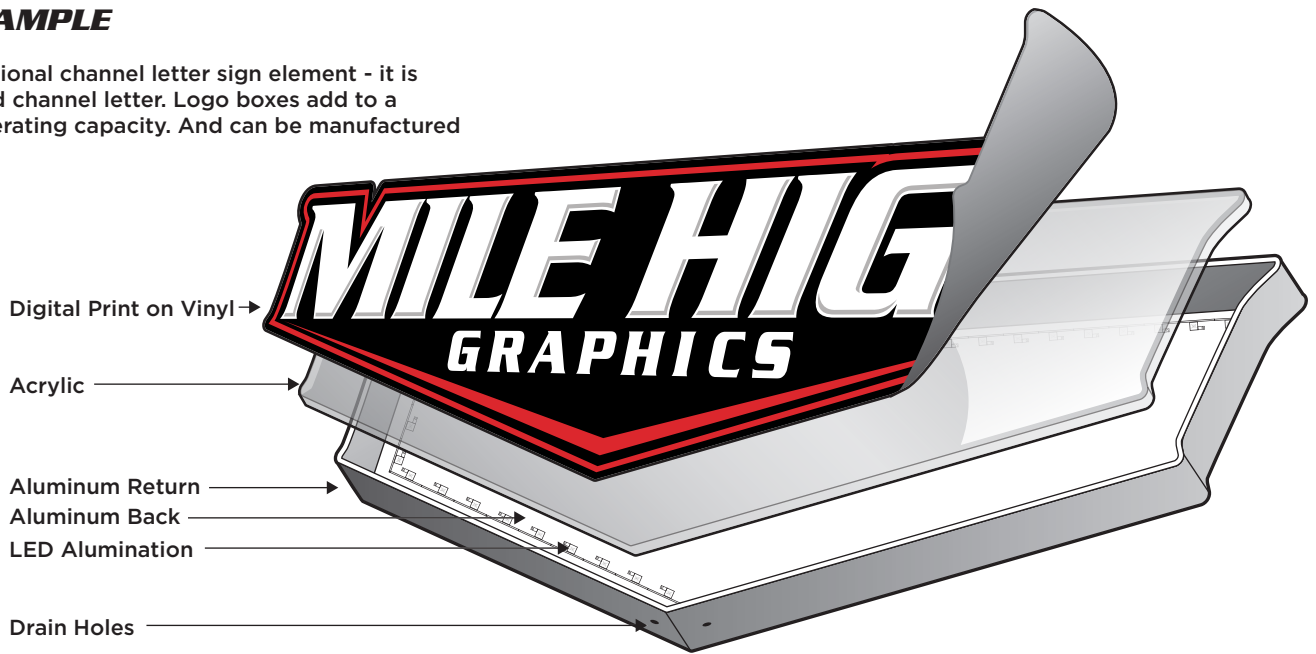

FRONT LIT CHANNEL LETTERS (RACEWAY)

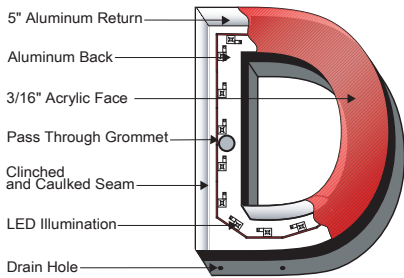

FRONT VIEW

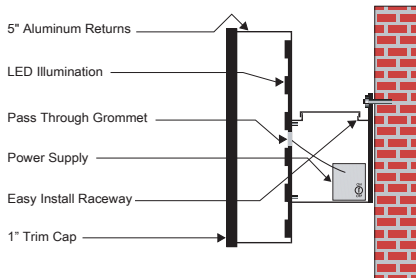

SIDE VIEW

REVERSE LIT CHANNEL LETTERS

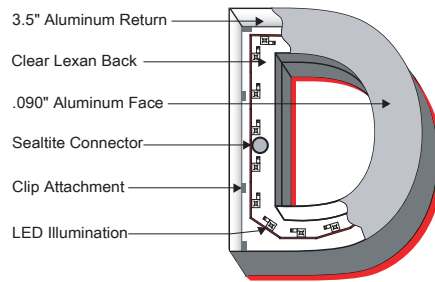

FRONT VIEW

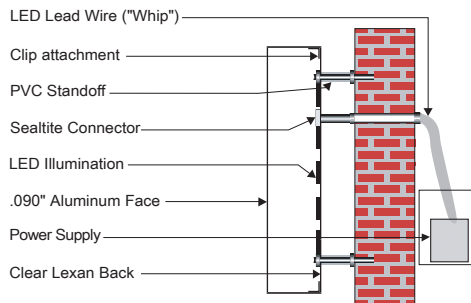

SIDE VIEW

FRONT/BACK LIT CHANNEL LETTERS

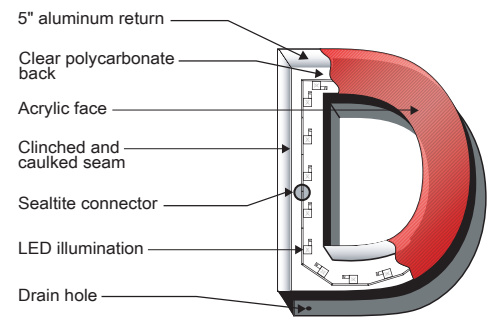

FRONT VIEW

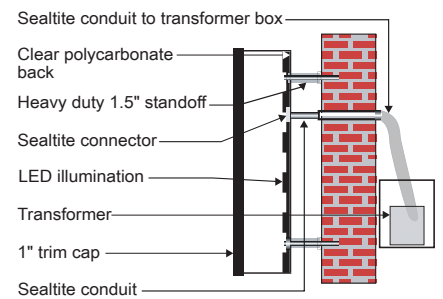

SIDE VIEW

Channel Letters

Vinyl Color Chart

Colors Shown Are 3M Translucent Vinyl Colors
Standard colors are in stock. Nonstandard colors can be special ordered from all major manufacturers. Available vinyl colors are not limited to the examples shown in this chart.*

*Colors shown are visual estimates, actual color may not match exactly.

222 Dual Color Black	141 Gold Nugget
005 Ivory	131 Gold Metallic
149 Light Beige	129 Bronze
121 Silver	071 Shadow Gray
051 Silver Gray	069 Duranodic
061 Slate Gray	059 Dark Brown
022 Black	063 Rust Brown
133 Raspberry	109 Light Rust Brown
078 Vivid Rose	049 Burgundy
068 Rose Mauve	

Vinyl Color Chart (continued)

108 Pink	146 Light Kelly Green
118 Intense Magenta	116 Bright Jade Green
053 Cardinal Red	026 Green
073 Dark Red	076 Holly Green
033 Red	126 Dark Emerald Green
083 Regal Red	236 Turquoise
143 Poppy Red	246 Teal Green
043 Light Tomato Red	317 Evening Blue
044 Orange	147 Light European Blue
084 Tangerine	057 Olympic Blue
074 Kumquat Orange	337 Process Blue
025 Sunflower	127 Intense Blue
075 Marigold	167 Bright Blue
125 Golden Yellow	097 Bristol Blue
015 Yellow	157 Sultan Blue
115 Light Lemon Yellow	137 European Blue
106 Brilliant Green	036 Blue
136 Lime Green	087 Royal Blue
156 Vivid Green	128 Plum Purple

Reveal Configuration

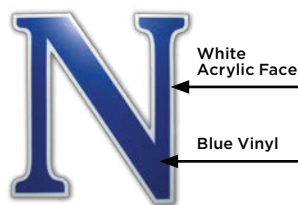

Border Configuration

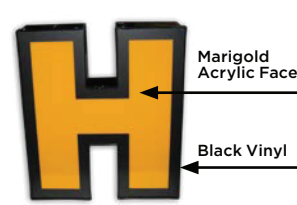

Full Cover

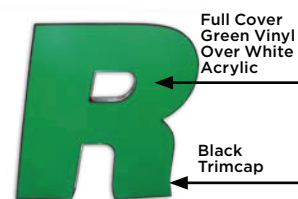

Channel Letters

Trim Cap Colors

1" Standard colors are in stock. Non-standard colors can be custom painted to match requested colors at an additional charge. Colors shown are visual estimates. Actual color may not match exactly.

Black	Shiny Bronze
White	Duranodic Bronze
Red	Teal
Holly Green	Intense Blue
Dark Green	Royal Blue
Yellow	Gold
Ivory	Orange
Dark Purple	Chrome
Burgundy	Brushed Chrome
Brown	Silver Metallic

Acrylic Colors

Standard colors in stock. Non-standard colors can be ordered from manufacturers, subject to availability. Digital print may be required to match specified color. Colors shown are visual estimates. Actual color may not match exactly.

*Diffuser Needed

#0000 Clear	#2030 Hunter Green*
#7328 White	#2108 Green
#2447 Mily White	#2146 Ivory
#2283 Red	#2016 Yellow*
#2415 Red	#2037 Yellow
#2793 Red	#2114 Blue
#2662 Red/Orange	#2051 Blue
#2119 Orange	Day/Night*

Return Colors

5" Standard colors are in stock. Non-standard colors can be custom painted to match requested colors at an additional charge. Colors shown are visual estimates. Actual color may not match exactly.

White	Dark Green
Red	Brite Green
Matte Black	Mocha Tan
Black	Ivory
Royal Blue	Burgundy
Chevron Blue	Brown
Gold	Duranodic Bronze
Yellow	Silver Metallic
Orange	Light Gray
	Dark Gray

WARRANTY

1. If any of the following components of the sign structure malfunction because of defects in workmanship or materials within 12 months after the date of shipment of the sign by Mile High Graphics (MHG) to the purchaser, MHG will at its sole option either repair or replace the defective materials:

- Trim Cap
- Acrylic Faces
- Aluminum Returns & Backs
- Raceways
- Secondary Wiring
- Tube supports, PK Housings, and other parts (other than those listed below)

2. If the neon illumination fails to function properly within 90 days after install of the sign by MHG to purchaser, MHG will at its sole option either replace defective units or reimburse the purchaser for repair of the defective units, up to \$35.00 per unit. A "unit" is defined as: One single stroke piece of neon. Double stroke neon up to \$50.00 per unit.

3. If a transformer fails to function properly within two years after the date of its shipment by MHG to the purchaser, MHG will at its sole option repair or replace the defective transformer; provided that the transformer must be returned to MHG by the purchaser for repair or replacement.

4. Labor to remove and reinstall defective items is not included in this warranty, and will be at purchaser's expense.

5. This warranty does not apply (i) if the purchaser fails to handle the sign/transformer properly and in accordance with any instructions from MHG, (ii) the sign/transformer is damaged after the sign is installed, and/or (iii) the purchaser misuses the sign, such as by damage, breaking or physical harm.

6. OTHER THAN AS SPECIFICALLY SET FORTH ABOVE, MHG MAKES NO REPRESENTATIONS OR WARRANTIES OF ANY KIND OR NATURE REGARDING THE SIGNS SOLD BY MHG; AND ALL SUCH REPRESENTATIONS AND WARRANTIES, INCLUDING (WITHOUT LIMITATION) ALL IMPLIED WARRANTIES OF MERCHANTABILITY OR FITNESS FOR A PARTICULAR PURPOSE, ARE EXPRESSLY DISCLAIMED BY MHG.

If you have any questions about this warranty, please feel free to call MHG at 720.583.6401